

Miner and News

Ella-Lynns
Ladies' & Children's Wear
See Our Selection of
Spring Dresses

By Mail — \$6.00 per annum

KENORA, ONTARIO, THURSDAY, MARCH 12, 1936

By Carrier — 15c per week

HIGH SCHOOL BOARD

MANY NEW TEACHERS REQUIRED NEXT TERM

The regular meeting of the Kenora-Keewatin District High School Board was held in the Council Chambers, Wednesday, March 11th. All members were present, as well as Mr. A. G. Richmond, Principal, and Mr. Mas. M. Hayes, Vice-Principal of the High School.

Mr. E. L. Carter, Chairman, welcomed Mr. Roger Prefontaine, Chairman of the Separate School Board, a visitor to the meeting.

Among communications received were the resignations from the staff at the High School, from Miss Alice Batho, Mrs. Anna Goddard and Mr. Peter Caruk. The Board regretted the loss of these teachers.

A letter requesting use of a classroom at the High School for the coming term was received from Jaffray-Melick School Area, but the Board was unable to grant the request due to lack of any extra space in the School.

Use of the High School Gymnasium was granted the Kenora-Keewatin Badminton Club for their Wind-Up Tournament to be held on Saturday, April 18th.

It was reported that the Public Address System recently installed

at the High School, as well as the Gas Controls needed attention to operate satisfactorily, and Mr. B. Martz, Chairman of Building, agreed to look into this matter.

Mr. F. Collins reported that word had been received that new regulations governing grants for the coming year had now been approved and would be forthcoming in the mail at an early date. As soon as these were received, the budget could be completed.

Mr. L. A. McLennan, Chairman of Management, reported that negotiations were still in progress with regard to Teachers' and Caretakers, and it was hoped that final settlement would soon be reached.

The Chairman of Property, Mr. A. Olson reported that relining of the coal-bin at the High School had been completed and estimates for further projects for the coming season were being tabulated.

The principal's report noted registration at the High School as eight lower than last month, but 24 above the corresponding month last year. Average attendance was

(Continued on Page 16)

ESTIMATES FOR DISTRICT INDIAN SCHOOLS, THREE QUARTERS \$MILLION

W. M. "Bill" Benidickson MP for Kenora-Rainy River Federal constituency, reporting from Ottawa, advises that estimates of the Indian Affairs branch of the Department of Citizenship and Immigration, provides for an expenditure, within the three Indian Agencies having headquarters in the constituency which will aggregate about three quarters of a million dollars. This will include new construction and also repairs, renovations, and improvements in educational establishments and also considerable help to housing.

At Sandy Lake in the north an item of \$30,000 has been set aside for construction of a two classroom school and two staff units, while at Fort Frances \$300,000 has been included to provide a start on the new dormitory building, three classroom block and staff units for an expected 120 pupils.

At St. Mary's School at Kenora \$15,000 is provided for a three bedroom staff unit, while a similar amount for similar construction is set for Sioux Lookout.

At McIntosh residential school \$20,000 will be spent to make

structural alterations, provide water supply and mechanical services.

A very interesting item appearing in the estimates is the sum of \$75,000 which is described as "Contribution towards construction of Joint School Facilities," which refers to an agreement entered into between the Department and the School Board of Jaffray Melick, which will provide educational facilities for 60 Indian pupils, and marks a new departure in dealing with the problems of integrated education.

The above noted items are for new construction, while the following items concern repairs and upkeep of buildings.

Repairs to day schools in Sioux Lookout area total \$3,000, while in Fort Frances \$2,500 and Kenora \$4,950 are assigned.

Repairs to the residential school at Fort Frances, prior to the occupation of the new school require \$5,000. Cecilia Jeffrey School gets improvements to the sum of \$6,500 and further repairs to Kenora residential school, probably St. Mary's - total \$7,500.

Sioux Lookout Residential school requires \$5,000, while repairs to the McIntosh Residential

school amount to \$25,000.

In his reply to an enquiry from Mr. Benidickson regarding the proposed expenditures in 1959-60 by the Indian department for the purposes of education and housing, the director of the branch advised him, that tentative plans provide for contribution from the Welfare appropriation of \$50,000 towards construction of 25 houses in the Sioux Lookout agency, \$15,400 towards construction of five houses in the Fort Frances agency, and \$31,500 towards construction of 19 houses in the Kenora agency. This is in addition to funds which have been assigned for repairs of existing houses in the three agencies.

Mr. Benidickson points out, as also does the director of the branch that these expenditures included in the departmental estimates, are, of course subject to approval of Parliament.

Mr. Benidickson expects to be advised at an early date regarding what reserves on which the department plans to construct houses.

Wednesday Sky Reveals "Celestial Spectacular"

Northwestern Ontario and Manitoba residents last night were provided with a celestial spectacular, when the planet Venus and a slim crescent moon seemed to almost touch one another. Many curious citizens phoned the M & N last evening to ask if someone was finally going to hit the moon with a satellite.

On checking with professor R. J. Lockhart of the University of Manitoba it was learned that every month the moon overtakes Venus, but at 5:00 p.m. yesterday she made her closest approach to the planet this year. Professor Lockhart said "Venus was actually millions of miles from the moon but to earth-bound observers only a point-seven degree arc separated the two."

He said, "It certainly provided one of the most brilliant and spectacular showings we've seen in some time."

Van Wallegem Brothers Bereaved In Death of Mother

Word has been received in Kenora of the passing of Mrs. Elizabeth Van Wallegem, widow of the late Jules Van Wallegem. The death occurred at Winnipeg, on Wednesday, March 10th, at her late residence, 276 Harrow Street and eight days after the death of her husband. She was in her 79th year.

She came to Canada in 1911 and was married in Winnipeg the same year. She was a member of St. Ignatius Church.

She is survived by seven sons, Jerome, Michael and Julian in Winnipeg, Lucien, Germaine and George in Kenora and Gerard in West-Bengal, India. Eighteen grandchildren also survive.

The McGee Funeral Home, Winnipeg is in charge of arrangements and friends are asked to omit flowers.

MRS. LAURA DEGAGNE, KEEWATIN PIONEER TO MARK 89th BIRTHDAY

DRIVER - TRAINING TESTS PLANNED FOR INSTRUCTORS

Regulations will be introduced, requiring that all driving instructors in the Province pass tests laid down by the Government, Transport Deputy Minister D. J. Collins announces.

Both prospective and established instructors will have to take the tests, but the latter may be given temporary licences while the scheme is being introduced.

Examinations for instructors will apply both to driver-training ability and character.

Mr. Collins said that these tests have been requested by quite a few of the instructors themselves.

Mrs. Laura de Gagne of Lake St. Keewatin will celebrate her 89th birthday on Saturday March 14th.

Born in Quebec near Hull in 1870 Mrs. de Gagne came to Keewatin in 1883 at the age of 13 and during the Riel Rebellion.

Her parents Mr. and Mrs. J. Desmaras with the rest of the family left Quebec with a group of French Canadians for the purpose of erecting a saw mill for D. L. and Bob Mathers. This mill was situated just west of where Keewatin now stands and is known as Slab Town.

To get to Keewatin it was necessary for those Pioneers to travel through the States to a point near Grand Forks where they boarded a barge north bound down the Red River to Winnipeg.

(Continued on Page 12)

Canada Leads In World Hockey - Defeats Sweden

PRAGUE, Czechoslovakia — Canada moved nearer to retaining the world Amateur Hockey Championship by defeating Sweden 5-0 today in Prague, Czechoslovakia.

The unbeaten Allan Cup champions from Belleville, Ont., now have won three straight games in the round-robin finals. Today's win also puts Canada in at least temporary possession of "first place with six points."

Czechoslovakia, unbeaten in two games, could regain a tie for first by beating Russia later today, but Russia is favored in this game.

In today's game against Sweden, Canada took a 1-0 lead in the first period, scored twice more in the second and added two more goals in the third.

The scoring was evenly divided between Wayne Brown, George Gosselin, Barton Bradley, playing-coach Ike Hildebrand and Lou Smrke. Bradley also assisted on Hildebrand's goal and picked up two of the three penalties. Red Berenson drew the other penalty in the cleanly played game.

Belleville's regular goalie, Gordon Bell, sat out today's game and was replaced by Merv Edwards who made only 17 stops in registering the shutout. The Swedish goalie, Karl Karstroem, had 40 stops.

Canada has two games remaining, one against the United States on Saturday and a windup match with Czechoslovakia on Sunday.

Auxiliary To Pinecrest Reports Many Endeavours

The regular monthly meeting of the Pinecrest auxiliary held in the Library at Pinecrest was well attended. Mrs. T. J. Thomas presided in the absence of Mrs. J. Saunders, president. Mrs. W. Lawrence, recording secretary read the minutes of the previous meeting and Mrs. M. W. Field gave the treasurer's report.

Mrs. A. Pitt convener of the Ways and Means Committee reported to the meeting. Members went on record in favour of having an annual appeal to organizations in all towns in the district.

Mrs. H. Bird reporting for "Hobby Craft" stated that a display table had been set up in the rotunda of the Lodge where novelties made by the hobby-craft class would be on sale.

Mrs. R. T. Cairney reported the purchase of an additional wheel chair, a loudspeaker for use in the sewing room and a new sewing machine all of which are greatly appreciated by the residents.

Mrs. A. Sorenson reporting for membership reported a membership of 43.

Mrs. J. F. Roy convener of the visiting committee said that organizations have been visiting Pinecrest regularly and that they have been most co-operative. Mrs. Cade of the hospital visiting reported several visits to residents who are patients in the hospital.

A letter was received from the Board of management which stated it was against the serving of tea in the Tuck Shop. The meeting then adjourned.

FOR SALE
LARGE, SPACIOUS 4 BEDROOM HOME
Fully Modern, Hot Air Oil Heating,
Centrally Located with View of Lake
FOR PARTICULARS APPLY
SUTCLIFFE AGENCIES LIMITED
INSURANCE - REALTORS
CUSTOMS BROKERS
Kenora, Ont. Phone 6474

HOUSES FOR SALE
MORTGAGE LOANS INCORPORATED 1906 CUSTOMS HOUSE BROKER
The Standard Realty COMPANY LIMITED
INSURANCE 318 2nd St. E. REAL ESTATE BROKER
Phone 8533

Red Cross Blitz - Tonight 7-8 o'clock

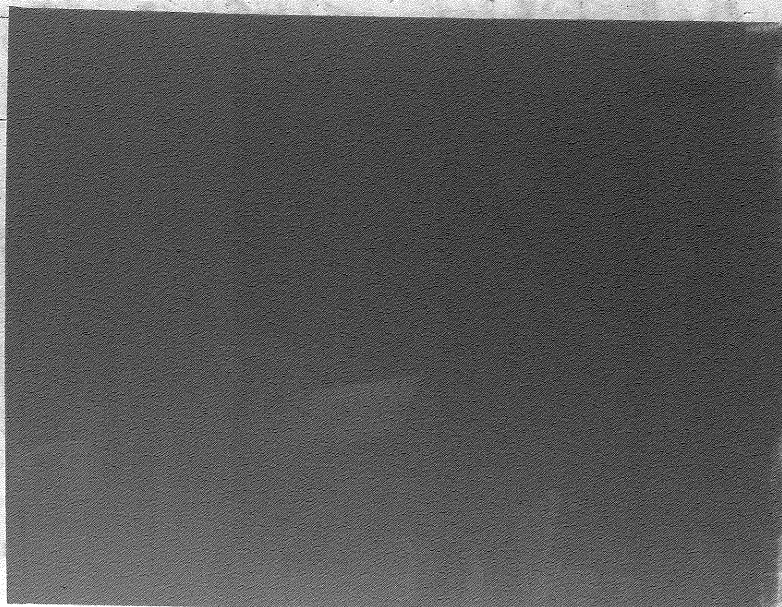

It's not every day that a carload of TV sets arrives in Keewatin. As a matter of fact, it happened for the first time on Monday, Bright and early Tuesday morning. Mayor Walter Hodgkinson and Mrs. Hodgkinson kindly took part in a brief "car opening" ceremony, (above) with His Worship breaking the seal. Bill Jones, proprietor of Customs Electronics, to whom the 250-odd TV sets were shipped, holds a gift for His Worship, while Mrs. Hodgkinson is seen carrying a bouquet of flowers, presented to her by Mr. Al Culchesky, Westinghouse representative for the district. It is interesting to note that the car (above) was sealed by the mayor of Brantford, home of the Westinghouse TV plant.

Work on the new hospital bridge is right on schedule, according to a Company spokesman. Tuesday morning marked the start of cement work, with concrete being poured into the north shore abutment.

Ministers Get Raises

TORONTO —The legislature has approved pay increases for two recently-appointed ministers without portfolio.

John F. Roberts, London, and John H. Root, Wellington - Dufferin, will get another \$2,700 each added to their regular allowances of \$5,400.

Members got \$3,000 as a seasonal indemnity and \$1,500 each for expenses. The ministers without portfolio will receive an extra \$1,500 indemnity and \$900 expenses.

The cabinet's other minister without portfolio, Robert Macaulay, Riverdale, will not receive the increase because he gets the equivalent for representing the government on the Ontario Hydro Commission.

Regular cabinet ministers receive \$10,000 a year.

Albert Wren (Lib-Lab—Kenora) told the House Tuesday it was time other members got more money for their services. Ross Wheeler (L — Bruce) said he didn't mind the ministers getting the increase but thought they should be given specific jobs.

No Evidence Gas Shares Corruption

TORONTO — Attorney-General Roberts says there is no evidence to show there was bribery or corruption in the handling of shares of the Northern Ontario Natural Gas Company.

Shares of the province's natural gas controversy came into the House again when the minister rose to answer a question put to him Feb. 19 by CCF Leader MacDonald.

Mr. MacDonald asked at the time if any effort was made to get information from President John McGraw of Continental Investment Corporation of Vancouver. Mr. McGraw had refused, Mr. MacDonald noted, to come to Toronto to testify about 245,000 shares of Northern Ontario handled by his firm.

Mr. Roberts said Tuesday the transactions in question "are what might be termed ordinary, every-day transactions."

A LETTER TO THE PUBLIC

In the spring of 1958 when the company of Sir Lindsay Parkinson commenced work on the Chukuni River Bridge, situated on the Red Lake road, the conditions of work and wages were so deplorable that it was necessary to attempt making some corrections, and to do so was to answer the worker's plea for organization.

For an example, here is what the workers had to contend with, prior to any action from the union on the company. They were compelled to handle materials such as cresote, which had left the men with severe hand and facial burns. Unlicensed and inexperienced personnel were operating draglines and hoists, which to many of the men's disappointment, would result in frequent cold duckings in the Chukuni River.

At one time, last summer, a dragline had fallen through the bridge, and sent a crew of men down into the river below, and it was only a miracle that had saved them from drowning. There was much evidence of this form of negligence on the part of the company on this particular job, and following a complaint from the union to the safety inspector, an investigation finally revealed that there definitely was negligence on the part of the company, and as a result, the machinery in question had to be tied up until the operator qualified himself for a license.

This was a great disappointment to the management, because this action on the part of the union and the inspector had affected certain practices that enabled the company to make at the expense of the workers.

In regards to the Kenora Hospital Bridge Construction which is presently declared unfair by the union, there exists also a great deal of disregard for the health and safety of the working men, whether they know it or not. Also, the firm employs very, very few tax-payer residents of this area of Kenora, and does not pay the complete area rates as per Section 108-6 "PAYMENT OF WORKMEN," in Department of Highways Ontario-General Conditions of the contract DHO Form 100-Revised April 1st, 1958, is as follows;

"The contractor shall pay the workmen employed . . . not less than the prevailing rates of wages, and the contractor shall cause each sub-contract . . . to observe this provision and . . . shall pay the workmen . . . at rates not less than the local prevailing rates of wages."

Prior to action taken by the carpenters union, men were laid off or fired, and not pulled off the job as the public is made to believe.

Further more, in the opinion of a company representative, we in Ontario are just a bunch of 'scruffs,' yet Sir Lindsay Parkinson had succeeded in building bridges with our tradesmen and salting away the profits.

This reminds us of the old time colonialism which had enslaved the workers to a point such as what the practices of this contractor indicate, and we as Canadians and Trade-unionists will never pull any punches on important issues such as this, and will at all times strive to correct such conditions that are detrimental to the working classes of this present day society.

The people of Kenora had waited a long time for the new Hospital Bridge, . . . and employment on same when this construction commenced, and thus far those hopes are squashed, and the efforts that the Carpenters Local Union 1669 is putting into correcting the situation, is not only our fight alone, but every one else's also, who lives and pays taxes here, is having certain rights defended. So Kenora get behind your rights and attempt to have them recognized.

The Premier of Ontario, the Hon. Leslie Frost, has been advised of the situation on this project and has been requested to take the necessary action on the safety hazards and employment conditions which exist.

W. SHERMAN,
Business Representative.

get all three: **VARIETY! QUALITY! SAVINGS!**

KEEWATIN AT SCOTT'S PHONE 2311

FREE DELIVERY — C.O.D. ORDER SERVICE

SUGAR GRANULATED 10 lbs. **\$1.00**

BACON 59c
EVERSWEET - RINDLESS
1 LB. CELLO PKG.

COFFEE NABOB REG. GRIND L.B. **69c**

BACON Swift's Premium Rindless lb. **72c**

LARD SWIFT'S 2 LBS. FOR **29c**

PICNIC HAMS 59c
FULLY COOKED
2-3 LBS. AVERAGE LB.

SOAP FLAKES MAPLE LEAF

MILK PACIFIC

CHICKEN Jenkin's Boneless 7½ oz.

DOG FOOD DR. BALLARD'S

Giant Size **79c**

6 TINS **97c**

2 TINS **97c**

3 TINS **39c**

WIENERS 47c
MAPLE LEAF L.B.

CAMPBELL SOUPS

Chicken - Mushroom - Scotch Broth - Vegetable Beef - Minestrone - Consomme

COD FILLETS Fresh Frosted lb. **39c**

3 TINS 58c

MINCED BEEF 89c
Fresh & Lean 2 lbs.

CANNED FRUITS 2 for 41c
PEARS OR CRUSHED PINEAPPLE 15 OZ. TINS

KLEENEX Regular Package 3 for **57c**

TOILET TISSUE Interlake 4 rolls **49c**

AEROWAX \$1.25
SELF-POLISHING HIGH GLOSS FLOOR WAX ½ GALLON TIN

SPECIALS IN THE DRYGOODS DEPARTMENT

LADIES' Plastic FOOTWEAR

Dominion "Rain Pair" Light and Dressy. High & Low Heals - Clear, Charcoal, Beige.

\$1.95 Pair

FLANNELETTE BLANKETS

In Good Quality Flannelette - Bound Edges White with Colored Border. Good Value.

\$4.79 Pair

PENMAN'S SOX FOR MEN

Smart - Dressy - Long-Wearing Pure Wool, Nylon and Wool Mixture

REGULAR \$1.00 **79c**

PHONE 2311 J. C. SCOTT & SON KEEWATIN

Mrs. Laura Degagne, Keewatin Pioneer

(Continued from Page 11)

deg. The party then came on to Keewatin by C.P.R. which was

then a single track. The entire trip took 10 days to complete. On arrival in Keewatin these Pioneers made temporary shelters for their families until the mill was completed and sufficient

lumber available to build their homes. Shortly after this the men built two churches, Protestant and a Roman Catholic. The present site of St. Louis R.C. church is the original landmark on the hill where all told three churches have been built and has been the place of worship for the Catholics in the Keewatin area for nearly 75 years.

At the age of 19, Laura Desmaras was married to Charles de Gagne in Rat Portage now Kenora. Being no roads or transportation in those days the wedding party walked to Kenora along the C.P.R. tracks and returning the same way after the ceremony. The whole community turned out for the reception which was held in the Mill Yard followed by old time dancing and French Canadian Folk songs.

In 1918 Mrs. de Gagne was left a widow with 11 children, seven daughters and four sons. The surviving daughters are (Jonnie) Mrs. A. Hanlen of Seattle, Wash., (Rose) Mrs. O. Faulknor of Quartz Hill, California, (Laura) Mrs. Emil Couture of St. Boniface, (Orees) Mrs. Paul Lavoie of Norwopod. The deceased daughters are (Edna) Mrs. Hugh McKinnon of Kenora and Ottawa, (Georgina) Mrs. Paul Tailfore of Montreal and (Blanche) Mrs. Percy A. Woods of Spruce Lake near Keewatin. The four sons are Louis on No. 17 Highway, Laurie, Edward and Paul at home with their Mother. Mrs. de Gagne is still enjoying fairly good health and spends her time looking after her home and the boys. She has 31 Grand Children and 36 Great Grand Children.

Many friends and relatives will be wishing her a Happy Birthday on Saturday.

DANCE

**LEGION AUDITORIUM
FRIDAY, MARCH 13th**

REFRESHMENTS — TOM BROWN'S ORCHESTRA
SPONSORED BY TRILLIUM TOASTMISTRESS CLUB

Tickets from Tilley's Drug Store,
Johnson's Pharmacies, Bus Depot

EVERYONE WELCOME

ADMISSION: 75c EACH - DOOR PRIZE

LADIES!

FASHION'S LATEST
TREND FOR SPRING
IS THE NEW

"Pouf"

HAIR - DO

FOR PERSONALIZED STYLING CALL
PROFESSIONAL AND EXPERIENCED OPERATORS



HELEN'S BEAUTY SALON

IN THE BERGMAN BUILDING - PHONE 8605
COLD WAVES COMPLETEfrom \$5.50 Up
SCALP TREATMENT COMPLETEfrom \$3.00 Up

TEA

THE KENORA C. P. & T. FUND
OF THE ODDFELLOWS AND REBEKAHS

will hold their

ANNUAL ST. PATRICK'S DAY TEA

in the HOTEL KENRICIA on

Saturday, March 14 from 3 to 5 p.m.

Novelties, Homebaking and Candy Tables

Come and enjoy a cup of tea, and
Help Us to Help Others

IT'S
FOR
YOU!

IT'S

London Lassie



Tailored elegance in a delicate tone-on-tone fabric that is in place—any place. Add this style to your London Lassie wardrobe. It features a one piece Italian collar in a particularly attractive little or no-iron fabric.

Available in sizes 12 - 20 in mint, blue and tangerine.
Only \$3.98 at your favourite store.

LONDON SHIRT CORP. MONTREAL

READ THE MINER AND NEWS CLASSIFIEDS

FLORIDA CALLING

Florida is calling! Visit several main attractions and enjoy yourself in Miami by going to the Wright Theatre, Saturday, Monday and Tuesday. We will be showing a really good half hour film on Miami, featuring all the beauty spots such as the Cyprus Gardens.

advt.

A box camera does the best job of "stopping" motion when the action is almost head-on to the camera angle or when it's at about 45 degrees to it.

Your camera should always be handy so that you won't miss spontaneous, on-the-spot situations right around home.

Don't be afraid to take a picture even though you are facing the sun. Backlighting pictures are more interesting.

Snow reflects the rays of the bright photographic subjects and use a smaller lens opening than usual.

When you MAIL a Parcel
PACK IT PROPERLY

use corrugated cardboard or a stout carton.



When you PACK a Parcel
WRAP IT PROPERLY

use strong wrapping paper and tie securely with strong cord.

When you WRAP a Parcel
ADDRESS IT PROPERLY

print name and address clearly, completely, correctly and in ink on front of parcel. Put your own name and postal address in upper lefthand corner, and also inside parcel.



For correct postage, check parcel's weight at your nearest post office.

CANADA POST OFFICE



BILLS AND PAYMENTS
OVERDUE....
WOE IS ME....
OH WHAT'S TO DO?



IT'S CASH YOU NEED,
'TIS PLAIN TO SEE
...SO OFF YOU GO
TO T.C.C.



A MOMENT'S ALL
THE TIME IT TOOK
AND LIFE TAKES ON
A BRAND-NEW LOOK.



THE ME
FOR A
...WHEN
SE



TRANS CANADA CREDIT

CORPORATION LIMITED
115 CHIPMAN ST., PHONE 9136

Why put up with money problems?

The solution to those worrisome bills is as easy as this: call Trans Canada Credit!

Loans from \$150. to \$2,500., or even more, can be arranged for up to 20, or 30 months.

So why not solve your money problem? Call us today!





D. F. McKECHNIE, C.P.A.

The Public Accountants Council for the Province of Ontario announce the election of Mr. D. F. McKechnie, C.P.A., of Ottawa, as its President, to succeed Mr. W. J. Ayers, F.C.A., of Toronto. Other officers elected were Vice-President - Mr. C. K. MacGillivray, F.C.A., of Hamilton, Secretary - Mr. Hamish Macdonald, F.C.A., of Toronto, Treasurer - Mr. G. B. MacDonald, C.P.A., of Toronto.

The Council draws to the attention of the public that all those who practise as public accountants in Ontario must be licensed under the Public Accountancy Act (Ontario) 1950, and must observe the code of professional conduct laid down by the Council. Any information regarding these matters and the penalties for non-observance of the Act and regulations may be obtained from Mr. P. J. Ambrose, Registrar, The Public Accountants Council for the Province of Ontario, Room 32, 2 Bloor Street East, Toronto, 5, Ontario.

Around Town

Out of town friends attending the funeral of the late Mr. McIlwaine, on Tuesday morning were:

Mr. John DeRosier, Mrs. A. DeRosier and Mrs. E. DeMontigny of Norwood, Manitoba.

Mrs. A. Menegie of Lorette, Marr.

Mrs. A. LeClair of St. Norbert. Mrs. E. Mousseau of St. Boniface. Mr. and Mrs. Martin Tribe of Dryden. Mrs. M. A. Hebert of Calgary. Mr. and Mrs. G. Straiger, Jean and Patricia of Norwood.



McLay — Cyndy and Susan are happy to announce the arrival of their baby sister, Roberta Marie, at St. Joseph's Hospital, March 9. Weight 7 pounds, 10 ounces. Proud parents are Dorothy and Neil McLay.

DEVINS — Faye and Bill are happy to announce the birth of their son William Fergus, on March 3rd at the General Hospital. Weight 6 pounds, 12 ounces. Many thanks to Dr. Bryngelson and nurses.

IN MEMORIAM
SMITH — In loving memory of our dear mother who passed away March 12, 1952.

We watched you suffer and heard you sigh,
All we could do was just stand by,
God took your hand, we had to part,
He eased your pain and broke our hearts.
You were always true and patient,
Through the years you struggled on,
Those hands that rest forever
Made the home that now is gone.
Please God forgive our silent tears
And constant wish that you were here,
Others were taken, yes we know,
But you were ours and we miss you so.

Lovingly remembered by your daughters Helen and Arlene.

CARD OF THANKS

I wish to take this opportunity of expressing my heartfelt thanks to all my friends and neighbours, for their many acts of kindness, cards of sympathy and beautiful floral tributes received by me during my recent sad bereavement in the loss of my beloved husband. Also my thanks to all who visited him during his illness.

A special thank-you to the Pallbearers.

Mrs. D. McIlwaine and his sister, Lizzie McLey of Ireland.

IN APPRECIATION

We would like to express our sincere thanks to the Kenora Thistle Hockey Club and executive in organizing "Ron Morgan Night" to help our son Wayne, who is in the Winnipeg Children's Hospital.

Special thanks also to Radio Station CJRL, Kenora Miner and News, Daily Reminder, The Empty Stocking Fund, and all those who assisted in any way to make the evening such a huge success.

Ron and Ethel Morgan.

CARD OF THANKS

We would like to take this opportunity to express our sincere thanks and appreciation to our many friends, neighbours and relatives for their beautiful floral tributes, messages of sympathy and acts of kindness during our recent bereavement in the loss of

our wife and mother.
Special thanks to Dr. Baker,
Father, Farron and the Brown
Funeral Home.
Art Elders and family.

Arizona is known as the "Grand Canyon state."

The early bird gets the worm . . .



DO YOUR SPRING DECORATING EARLY THIS YEAR

SPECIALS

QUALITY ENAMEL	Quart	\$1.69	Gallon	\$5.98
QUALITY FLAT WALL	Qt.	\$1.39	Gal.	\$4.69

THESE PAINTS AVAILABLE IN WHITE ONLY BUT CAN BE TINTED IN MANY BEAUTIFUL COLORS

WALLPAPER

ALL HIGH QUALITY PAPERS IN STANDARD STOCK PATTERNS..... **10% OFF**

SOME AS HIGH AS **20% TO 30% OFF**

Sale Starts Monday, March 2 to Saturday, March 14 or While Stocks Last

Sherwin - Williams

PAINT AND WALLPAPER STORE

PHONE 6773

109 1/2 MAIN STREET

KENORA

REMEMBER . . . WE'RE STILL FIRST!

WE WILL MAKE THE FIRST REGULAR PAYMENT ON ANY Advertised "Quality" USED CAR

FROM

WESTARIO MOTORS

OPPOSITE THE FIREHALL

PHONE 8993

DRAL'S PLAIN ALL TO SEE YOU NEED CASH E.T.C.C.



Satellites To Photograph Earth

CAPE CANAVERAL, FLA.—Nine giant camera satellites will be fired into orbit aboard powerful Atlas missiles starting next September, informed sources say.

Persons close to the project reported the camera satellites, weighing about a ton, will be blasted into short-lived orbits to take pictures of most of the earth's surface, including the heartland of the Soviet Union.

The program, called "Project Sentry," will use a two-stage Atlas ICBM as the booster for the bulky payload.

There were no details on the camera itself or how it would perform, but it was learned that the project was shifted to the Cape from Vandenberg Air Force Base, Calif.

Sentry is just one of a number of important space roles being assigned the workhouse Atlas which soared into orbit on its own last Dec. 18.

In June, the 360,000 pound thrust rocket will be the first stage vehicle for a probe to the planet Venus. Later, Atlas will have the job of shooting the first man into space.

It was learned that the decision

to move Sentry to the Cape was made to take advantage of the extra 1,000 m.p.h. kick provided by shooting in the same direction as the earth's rotation. The satellite must reach a speed of more than 18,000 m.p.h. to attain orbit.

Weight Tax Considered

TORONTO — Transport Minister Yaremko said Monday the Ontario government is considering a weight tax on heavy trucks.

The minister was replying in the legislature to a statement by CCF leader MacDonald that any increase in gasoline tax would shift an unfair burden on private car owners. Mr. Yaremko said the government is aware of that.

Mr. Yaremko said transports of more than eight tons represent only 3.1 per cent of the total vehicle registration in the province but contributed more than 30 per cent of the total registration fees.

The minister also said the reduction of Ontario traffic deaths to 1,112 in 1958 from 1,279 in 1957 was better than any other province and 45 of the 49 United States.

Under the new demerit system in Ontario, said Mr. Yaremko, "If a man refuses to obey the laws then he will simply be taking himself off the road."

Royal Life Saving Society Clinic Set For Lakehead

The Royal Life Saving Society, Ontario Branch, in cooperation with the Community Programmes Branch of the Ontario Department of Education, will sponsor a clinic on Friday evening, March 20 and Saturday afternoon, and evening, March 21, 1959 at the Fort William Y.M.C.A.

Instructors for the Clinic will consist of Mr. Norm West, of the Royal Life Saving Society Executive, Toronto, and Mr. Allan Sivell, Royal Life Saving Society Executive, Toronto, or Mr. Kirk Whipper, Vice-President of the Royal Life Saving Society, Toronto.

The Clinic is open to anyone interested in Royal Life Saving Society activities and will consist of lectures, films, discussions, demonstrations in the swimming pool and a review of test items and examination procedures.

Further information and application forms may be obtained from your local Recreation Committee or the Community Programmes Branch, Ontario Department of Education, Fort William. (Phone 2-4859).

Anna Pavlova, the Russian ballerina who died in 1931, entered the Russian ballet at age 10.

GIRLS CRASH ALL-MALE STRONGHOLD

Ann Arbor, Mich.—Things are different now in the naval architecture classes at University of Michigan.

The men no longer tell salty stories, and they outdo themselves in being polite.

Pretty red-haired Judy Robinson of Monroe, Mich., was the first co-ed to break in the previously exclusive male circle. Now a senior, she has been joined by two other girls.

"I guess I've been accepted by now," she said. "For they elected me, appropriately enough, purser of the Quarterdeck Society."

Darien Pinney had trouble convincing the Society of Naval Architects and Marine Engineers she is a co-ed.

"They kept sending me literature addressed to Mr. Darien Pinney," she says. "They finally stopped after I sent them a sweet note on perfumed, pink stationery."

ATTENTION

ALL MEMBERS

of
LUMBER and SAWMILL WORKERS UNION
LOCAL 2693
(WOODS DIVISION)
EMPLOYEES OF THE
DRYDEN PAPER COMPANY LTD.

Your Delegates and Officers of Local 2693 have reached a settlement of agreement with the Dryden Paper Company Ltd. A special meeting is being called for the purpose of ratifying this agreement.

PLACE - DRYDEN HOUSE (Downstairs)
DRYDEN, ONTARIO
DATE - SUNDAY, MARCH 15, 1959.
TIME 2.00 P.M.

You are requested as a member of the Union to make every effort to be in attendance.

Signed:
A. E. McDowell,
Treasurer,
Local 2693.

COLORFUL
Low Cost
ADVENTURE



ALASKA CRUISE

sailings
from Vancouver
JUNE 3 to SEPT. 1

ALASKA... land of legend history and adventure. For a thrilling vacation... a life-time memory — cruise by smart Princess liner through the famous Inside Passage to the Land of the Midnight Sun... Prince Rupert... Ketchikan... Juneau... Wrangell... Skagway.

2,000 mile, 7½ day cruises as low as \$225 from Vancouver to Skagway and return.

Full information and reservations from any Canadian Pacific office.



To Provide Better Service for the Children of Kenora . . .

ELLA-LYNN'S

announces the opening of a

New Children's Department

It is the desire of the management to provide a Better and More Complete Service for age groups from infancy to 6x. To introduce our new department we are offering a

20% REDUCTION

On All Children's Purchases

Made Friday & Saturday, March 13 & 14

LIL ABNER



RUSTY NILEY



WANT-AD ORDERING MADE EASY

Phone 8936 - Say "Charge It"

FOR SALE

FOR SALE — 1955 Monarch. Good condition. Will take trade of '50, '51 or '52 models. Phone 6633.

FOR SALE — Marconi Combination radio phonograph 3 speed. In perfect condition. Reasonable price. Phone 7861.

FOR SALE — Fully modern revenue bearing home, 4 rooms for owner, two rooms and kitchenette upstairs. Fully landscaped. lot. Garage, F.A. oil heat, full basement. \$3,500.00 down payment. Write to Box 42 Miner and News, Kenora, Ont.

FOR SALE — 3 bedroom, fully modern home in Rideout \$7,000 cash for quick sale. Apply Box 38 Miner and News.

FOR SALE — Modern 3 bedroom house with garage in Donkirk Heights. Phone 6920.

FOR A COMPLETE SELECTION of baby furnishings, cribs, mattresses, strollers, carriages, play pens, high chairs. See the display at Delanere and Tilley's. Free estimates on Custom Made Drapes and wall to wall carpets. Phone 7272. Delanere and Tilley of Kenora.

FOR SALE — House, 3 years old. In Norman. Phone 9515 after 6:00 p.m.

House Trailers

REDUCED FOR QUICK SALE

- 33' x 8' UNITED
 - 28' x 8' WHITLEY
 - 28' x 8' BUDGER
 - 21' x 8' AMERICAN
- ALSO A
2 BEDROOM 33' x 8'
- Trades and Terms Accepted
Can be seen one mile west of Keewatin

FOR RENT

FOR RENT — Room for gentleman. Reasonable rent. Central. Phone 9419.

FOR RENT — One furnished room. Central. Phone 9312.

WANTED

WANTED — Responsible, capable housekeeper. Permanent position in pleasant home. Must be fond of children. Phone 9475.

WOULD ANYONE HAVING copies of the Miner and News for March 6 and 7, please leave them at the office.

SALES REPRESENTATIVE REQUIRED

To enroll Motor Club memberships in this locality. The Ontario Automobile Association provides the finest in Motor Club benefits. Pleasant work that can be handled either full or part-time. Rush your name and address for full information as territories are being allotted now. You should have a car and be from 25 to 50, male or female. Write Sales Manager, Box 817, London, Canada.

MISCELLANEOUS

A.A. - Relocating? For full information on Job Openings, Housing, Prices, etc., we will send you current copies of every daily paper from any two cities you wish in Canada or United States for \$2.00.
BOOKSHOP
Eridale, Ontario

Funeral Directors

Brown Funeral Home (Kenora) Ltd.
Funeral Directors
420 2nd St. S. Dial 8633

"Say It With Flowers"
We Specialize In Wedding Arrangements and Funeral Designs
Ken Page - Florist
PHONE 3215

PROFESSIONAL

H. E. CHURCHILL
CHARTERED ACCOUNTANT
113 Main St. — Phone 6882

JACK E. DONEY, L.L.B.
Barrister and Solicitor
Imperial Bank Building

T. A. O'FLAHERTY
Barrister and Solicitor
Law Office, Bergman Building
2nd Street South — Phone 8888

W. EDGAR NORTON, D.C.
"Doctor of Chiropractic"
CHIROPRACTOR
Standard Block — 126 Main St.
Monday thru Friday
9.30 - 12 a.m. — 1.30 - 5.30 p.m.
Saturday — 9 - 12 a.m.
Evenings by Appointment Only
Phones
Res. 9648 — Office 9563

HARE, GORK, WATTEES & CO.
Chartered Accountants
204 Standard Block,
129 Main St. South
Kenora, Ontario
Phone 9910

H. D. Tansley F.A.A.O.
AND ASSOCIATE
OPTOMETRISTS
Hours: 9 - 5.30 — Wed. 9 - 1
(Next to the Public Library)
50 Main St. S. — Phone 7047

ED'S EAST END SERVICE
Opposite CPR Round House
Reg. Gas 44.5 Per Gal.
Repairs of all Makes of cars
PHONE 9728

KENORA JEWELLERY
Gifts for All Occasions
Watches and Repairs
Jewellery
LOCATION - Corner of Second St. S. and Matheson St.

Government Certified High Pressure Welder

METAL FABRICATING and WELDING SHOP
• Ornamental Iron Work
• Steam Boiler Repairs
• Electric Welding
• Torch Cutting
• Repair Work
PHONE 7688

1451 Pine Portage Road
Kenora, Ont.

Off the Cuff

(Continued from Page 2)

Bon ami John Tarran finally arrived in Kenora on a CPR box car . . . He has just returned from a six month trip to England and France . . . His two articles, which will appear in OFF THE CUFF shortly, tell about England re-visited . . . It should be of interest to you people who know the merry old country . . . He has seen many sporting events etc., and even managed to see folk-singer Harry Defalonte . . . Should be well worth reading . . . John's quite the story teller . . .

Coming events to keep in mind: High School Basketball at the High Gym this weekend (Saturday) . . . The Mustangs will clash with Silver Heights senior basketballers while the Colts will meet the Deer Lodge Junior team . . . The Kenora teams played these two teams in the 'Peg and defeated them . . . Try and attend both games Sat. evening.

Good pal Dick Copeland passed this along from the Winnipeg Tribune . . . Jack Humphreys, a veteran scout of the New York Rangers, who is on a swing through the prairies reports that Gary Bergman looks very impressive as a defenceman . . . Bergy is a Kenora lad as most of you know . . . We might add

Mastercraft UPHOLSTERS
Custom Made
Draperies and Venetian Blinds
Canvas and Metal Awnings
Dial 7683 For Free Estimates

NOW EXCLUSIVE AGENTS FOR OFFICE SPECIALTY
FEATURING
Desks - Filing Cabinets - Office Chairs - Filing Systems
The Finest In Canada
PAT'S KENORA STATIONERY and NOVELTY SHOP
Phone 3769

EARL PETERSON
SALES REPRESENTATIVE
217 - 6TH STREET PHONE 5227
GLENN CATES
RESIDENT SERVICE MAN
210 - 4TH ST. NORTH KENORA
PHONE 5192
POWELL EQUIPMENT CO., LTD.
YOUR "CATERPILLAR" DEALER

KENORA DAILY MINER AND NEWS
Published every afternoon, Monday through Saturday at 334 Second Street South, Kenora, Ontario.
The Kenora Miner and News Limited, Stuart King, Publisher and Editor, Bill Wylie, Advertising Manager, Frank Goodolphin, Comptroller, Member of the Canadian Daily Newspaper Association. All rights of republication of local news or special dispatches published here are reserved. Authorized as Second Class Mail, Post Office Department, Ottawa.

Prince George
DOWNTOWN AT 800 AND YORK STS.
Specializing in service to restaurant and executive. Free 5 channel T.V. or conditioned sound housed rooms. Call Henry. Rate from \$7.00.
Reservations: Sample rooms available. Reservations for the location of P. O. Highway, Ont. Reg. See Reservations with CHANCE

FOR ALL YOUR PAINTING and Decorating Supplies



SEE US FIRST AT
SHERWIN-WILLIAMS
PAINT and WALLPAPER STORE
Phone 6773 — Main Street — Kenora, Ont.

here that Humphreys knows his hockey business and if he says Bergman is good then Bergman must have great potential . . . Gary also has a promising football career . . .

Noticed in the Hockey News a picture of our own Thistle coach, Chuck Rayner pic tells about goalie Ray Mikulan, who used to toil with the Warriors of the Western Hockey League . . . Mikulan, who is still in the WHL, reports that Rayner taught him in Nelson B.C. how to become a goalie . . . Ray says that Rayner gave him his start . . .

Lake of the Woods Indians have had success thus far in their District play-offs against Dryden . . . They defeated the Legionaires from the near east, 9-6 on Tuesday . . . They play again to-night in Dryden. With a three goal lead in this best of two total point series, the Indians will have to keep the hungry for victory Dryden team from winning . . . Three goals isn't a great margin of safety . . . If Tony Leonard's boys win this evening they will advance in the Provincial play-offs which will be held at the end of March in Fort Frances . . .

We can't see these two game total point series at all in this day and age . . . The Indians, if they win, will have a long lay-off before going to Fort Frances . . . Tony Leonard is counting on exhibition games before the Provincial play-offs, if his club should make it . . . Tony says, "I know a number of teams that have lost good players before the final play-offs by having them get injured in exhibition encounters" . . .

By the by, the Provincial play-offs were to be held in Kenora this year . . . BUT WE LACK artificial ice; therefore, Fort Frances was the lucky town . . . Typical Kenora Luck . . . see you at the Thistle ice soir . . .

Varied Topics Highlight Jaffray Institute Meeting

The regular monthly meeting of the Jaffray Womens Institute was held March 6th at the residence of Mrs. A. R. Ascough, Rabbit Lake.

The President Mrs. W. Thompson presided at the meeting and welcomed the sixteen members present.

The meeting opened with the Institute Ode followed by the Creed. Roll call was the question "Should Women Institute members accept office on the school board?" The majority answer was yes.

Secretary-treasurer Mrs. W. Kelso read the minutes of the previous meeting, then read the correspondence.

Mrs. A. R. Ascough reported new pages containing many clippings were added to the Tweedsmuir History and were available for the members to read.

Mrs. C. Kearney reported on the recent course "The Third Meal" and said that the course was very interesting and helpful to all members attending. Mrs. C. Kearney then read an article on the farm safety program to curb the accident toll on farms.

Mrs. S. Lambert read a paper regarding cleanliness of the Litterbug.

Mrs. R. James gave a very interesting talk on Citizenship Court, explaining the oath and the impressive ceremony.

Mrs. A. Davidson reported that Mrs. Taylor managing the national affairs of the Federated

Womens Institute from a homey one room office, had now opened a new large office on Confederation Square in Ottawa.

"The Milky Way" will be the project of the Girls 4H Home-making Club this spring. Mrs. D. Campbell leader with Mrs. J. Shumka assistant leader.

The members congratulated Mrs. S. Hoare on her birthday and sang Happy Birthday, Mrs. Hoare also won the travelling prize.

The meeting closed with the singing of the Queen.

A social half hour followed conveners of the lunch were Mrs. A. R. Ascough, Mrs. R. James, and Mrs. W. Thompson.

The next meeting will be held at the residence of Mrs. C. Kearney, Airport Rd.

Sven Bowman
ELECTRICAL CONTRACTOR
• Wiring
• Lighting
• Fixtures
• Estimating
PHONE 7447
110 Regina Ave.

THE MAN FROM HARE'S
Says:

He Has Several Mobile Homes

• One only 33' x 10' Twentieth Century, 6 sleeper, completely furnished and ready to move into.

• One only 37' x 10' General, 6 sleeper, completely furnished and ready to move into.

Prices Slashed on These for Quick Sale

W. H. MARR LTD.

400 Railway St. - Phone 6404
INTERNATIONAL CONSTRUCTION EQUIPMENT DISTRIBUTORS

KENORA'S NEWEST FLOWER SHOP

"The Glenne"
FLOWERS FOR ALL OCCASIONS

SPECIALIZING IN
• Wedding Bouquets
• Funeral Arrangements

Orders for Keewatin taken by Custom Electronics Enterprises - Phone 2561

"The Glenne"
Formerly Foster Florist
18 Main St. S. - Phone 3955

Many New Teachers Required

(Continued from Page 1)

eleven below that of last February, but sixteen above that of the same month last year.

A statement of the Cafeteria showed a total loss this season to date of approximately \$143.00.

Concerning Career Day, held February 25th, it was reported that thirty-five leaders in their respective occupations visited the school to discuss with students the merits and demerits of their own chosen life work. Approximately 400 pupils had a chance to take part in the discussion, and the students appreciated their help very much. The undertaking had been exceptionally well organized by Miss Alice Batho, Guidance Director; and her committee.

Mr. McLennan and Mr. Martz both reported that they had had the privilege of addressing students and were much impressed with the interest shown.

During Education Week, March 1st to 7th, Mr. Richmond, principal reported that 456 parents had visited the school.

The following replacements for Staff would be needed for the coming term, a science teacher to include grades XI and XIII Physics, English and Part-time Librarian and Guidance Director. Members were of the opinion that three extra Grade XII general classrooms would be needed and that at least two extra teachers be hired.

Mr. McKinnon of the Teachers' College at North Bay had talked to a group of 20 students at the High School in Grades XI and XII who have signified an interest in qualifying for elementary school teaching.

OPP Proud Possessors Of Curling Trophy

The Kenora detachment of the Ontario Provincial Police are very proud of a curling trophy presently in their possession which was won by a rink skippered by Cpl. Maurice Stewart with team mates Sgt. Bill Parfitt, Const. Alex Forrester and Const. Bill Chop. The handsome trophy donated by Northland Machinery Co. Ltd. is emblematic of supremacy in the North-western Ontario Police Association curling.

The Stewart Rink won the trophy in the quarter finals, held at the Lakehead when they defeated a Port Arthur CNR police team. This is the second year the trophy has been up for competition.

In addition to bringing home the trophy, the boys each received a small replica and electric shavers.

MEN'S CURLING SCHEDULE

Thursday, March 12th
7 PM

McCunn - Munroe
Greenslade - Budworth
Boquist - Toole
Guy - Clifton
Lysen - C. Lindstrom

9 PM
Kippen - Webb
Howard - Ramberg
Beaton - Wismer
L. P. Johnson - Evans
Laverne - Jackson

Friday, March 13th
7 PM

Engstrom - Sweeney
Holmstrom - Macdonald
Playfair - Kleinendorst
Scott - Bowman
Sinclair - Brown

9 PM
E. Lindstrom - Smith
Scribilo - Whittaker
Wickstrom - King
Dingwall - Davidson
Pike - Chandonet

Saturday, March 14th
7 PM

K. Johnson - Laverne
Williams - Kippen
Foy - Howard
Foy - Boston

W. Johnson - L. P. Johnson
8 PM

Forsythe - Lysen
Reid - McCunn

Marchant - Greenslade
Harris - Boquist
Redding - Guy

Monday, March 16th
7 PM

Sinclair - Oshiro
Engstrom - Cameron
Holmstrom - Wallin
Playfair - Kimberley
Scott - Berry

9 PM

Pike - Peterson
E. Lindstrom - French
Scribilo - McInnes
Wickstrom - Norman
Dingwall - Sutcliffe

Tuesday, March 17th

Chandonet - Jackson
Smith - Webb
Whittaker - Ramberg
King - Wismer
Davidson - Evans

9 PM

Brown - C. Lindstrom
Sweeney - Munroe

Macdonald - Budworth
Kleinendorst - Toole
Bowman - Clifton

ROYAL FARM MUST PAY ITS WAY

SANDRINGHAM, Eng. — It's a rare day indeed when the Queen and the mundane matter of money are mentioned in the same breath.

Today it happened, and the cause was the price of peas.

Queen Elizabeth and Prince Philip have threatened to cancel a pea-growing contract with a frozen food company.

Further more, if the frozen food company change its pea-buying policy it can haul away its \$3,400 pea separating machine from the Royal Farm in Norfolk.

The controversy came up when the company decided to pay \$126 a ton for peas instead of paying by the acre.

The company said no profit could be made paying by the acre

and the Royal Farm found there was no profit in growing peas for \$126 a ton.

—The Royal Couple have told manager—Roger—Muttimer—that Sandringham Farm "must be

made to pay its way."

South Africa expects to change its currency from pounds, shillings, and pence to the decimal system in 1961.

COLORING CONTEST WINNERS

The following are the winners of the third Easter Coloring Contest.

FIRST PRIZE - 1 Camera - valued at \$5.95 from Lake-wood Studio won by 5 year old Diane Landry, Norman, Ontario. Diane enclosed a sales slip from Bill's Shoe Box.

SECOND PRIZE - Two Books of Paramount Theatre Tickets won by 7 year old Meran Wilson of 703 4th Ave. S. Her sales slip was from Acme-Kenora Cleaners.

THIRD PRIZE - One Book of Paramount Theatre Tickets won by 9 year old Judy Anderson, 815 4th St. N. She enclosed a sales slip from Bill's Shoe Box.

The picture to be colored for the fourth week's contest will be published Saturday in the Kenora Miner and News. Boys and girls aged five to twelve are eligible to enter, but each entry must be accompanied by a sales slip from one of the participating merchants.

The Best Steaks Money Can Buy!

T-BONE SIRLOIN

RED or BLUE GRADE BEEF

SAFEMWAY TRIM

Porterhouse

LB.

79c

Side Bacon

69c

Woodacres First Grade..lb.

LEG OF PORK

ANY CUT

55c

SPARE RIBS

FRESH

LIGHT

SIDE

.....LB.

39c

PRE-EASTER HAM SALE

HAMS

Ready to Serve

First Grade

All Leading Brands

WHOLE OR SHANK PORTIONSLB.

55c

SAFEMWAY SELLS FRESHER FRUITS AND VEGETABLES

ORANGES

California

Sunkist

Navels Size 138's.

3 doz.

\$1.00

GRAPEFRUIT

POTATOES

Florida

12 for 75c

SEEDLESS - SIZE 48's

Can. No. 1

Netted Gems

50 lb. Bag

\$1.29

LOOK FOR SAFEMWAY - BRAND FOOD SPECIALS IN OUR FLIER

PRICES EFFECTIVE
TO SAT., MARCH 14
OPEN 'TIL 9.00 P.M.
FRIDAY NIGHT



SAFEMWAY

Jack Watterson Ltd. MEN'S SHOP 153 Main Street E. - Phone 7222



SPORTS PAGE



A. A. P.O. Box 463 Lake of the Woods Group of Alcoholics Anonymous

DARTS

The competition for the J. Bynski Trophy continued Wednesday evening at the Keewatin Legion...

Kenora Legion trailed badly with 9 points for the evening. J. Bynski got himself a "six" with a top score of 134.

League standings to date: Keewatin Legion 151 1/2

Paramount

TONIGHT - FRI. - SAT.

FRANK SINATRA TONY CURTIS NATALIE WOODS

KINGS GO FORTH

Also: News Show Times: Mat. 2.15 - Eve. 7.15 and 9.25

Patrons Please Note: No Matinee Tuesday or Thursday Visit Our Comfortable Smoking-Lodge

Coming Attractions: The Decks Ran Red - adult; Cat On A Hot Tin Roof - adult; Me and the Colonel; In Love and War - adult



ELMER'S THEATRE PARTY PRIZES AND FUN FOR ALL!

PARAMOUNT

KIDDIES... This Saturday Morning at 10 a.m. see THE LONE RANGER and that WONDERFUL HORSE CALLED SILVER... HY HO... The First Lucky Ticket Number wins a Nifty Pair of Cowboy Boots...

Fur, Fin and Campfire

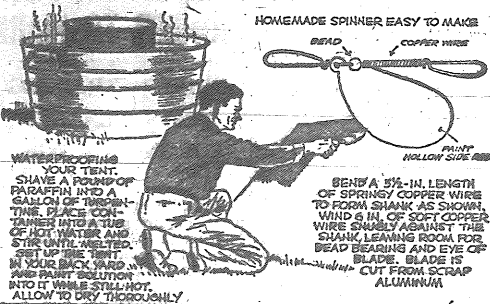

DON'T GROW COMPUSED LEARNING ALL THE KNOTS, THESE KNOTS WILL SERVE YOU VERY WELL

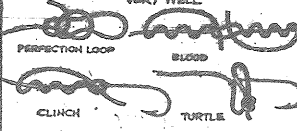

PERFECTION LOOP - FOR MAKING A LOOP IN THE END OF A LEADER OR BAIT-CASTING LINE. BLOOD KNOT - FOR CONNECTING STRANDS OF LEADER AND FOR JOINING TWO ENDS OF BAIT-CASTING LINE. CLINCH KNOT - FOR TYING LEADER TO STRAIGHT OR RIMMED EYE HOOK. TURTLE - FOR TYPING LEADER TO TURNED-DOWN OR TURNED-UP EYES

Off the Cuff by Rick Hunt

THE END OF THE LINE? ? The Fort Frances Canadians are in a rather good position to put the finishing touch to the Kenora Thistles' hockey coffin...

will have his boys breaking in the first period to secure a good first stanza lead... Rumours say the Fort team will have all hands on deck to wipe out the remaining bit of hockey that is left in the Thistles...

WRIGHT THEATRE

SHOWING THURSDAY and FRIDAY EVENINGS THE BEAST OF BUDAPEST Feature Starts 7:00 and 9:30 p.m. ALSO THE BRIDE AND THE BAST Showing at 8:10 p.m. Only ADULT ENTERTAINMENT

Norman Community Club TODAY 0-75

NUMBERS TO DATE: O-84; N-32; 1-23; G-51; B-14; B-9; G-57; G-58; N-39; I-18; G-59; B-4; G-54; N-44; B-11; N-40; G-47; G-55; I-20; N-36; N-38; O-69; N-33; O-58; B-19; G-48; I-30; N-37; N-35; O-73; I-15; B-8; I-28; O-48; O-72; O-68; B-1; N-42; O-74; I-27; O-57; I-21; O-62; G-52; I-22; N-43; N-31; G-48; G-48; N-41;

Kenora Legion 141 Sergeants 139 1/2

Nipigon Flyers Take Lead In North Shore Finals

Marathon - The outstanding North Shore Hockey team, the Nipigon Flyers continued their winning streak Tuesday night when before 1,000 Marathon fans they defeated the powerful Marathon Mercurys by a score of 7-4 to take a 3-2 lead in the Shore League's best-of-seven final series.

The Flyers outscored, outskated and outclassed the Marathon Mercurys. This was the second time in a row that Nipigon has defeated Marathon on home ice. The game featured hard checking on good ice and Marathon's second line of Romano, Moon, Lanteigne accounted for three of the four Marathon goals...

In the first period Nipigon scored two goals. At 8:34 Korpi assisted by Dupuis scored even though Nipigon was short handed at the time on a pass from Dahl and Legacy. Osa put home the final goal of the period at 17:26. Penalties Borsh Nipigon interference 7:51, Deluca Marathon tripping 11:55, Romano Marathon charging 19:30.

In the second period Nipigon scored four goals to Marathon's three. At 3:15 Osa again proved a live spark when he scored on an assist from Legacy and Dahl. At 6:31 Legacy assisted by Dahl and Osa scored. Herman, Manilla made the score 5-0 at 6:52

on an assist from Ward, At 9:30 Ed Bolan on a pass from Charyno slapped in Marathon's first goal from the blue line breaking Ruth's shutout. At 10:46 Baxter Nipigon's hottest goal getter scored on an assist from H. Manilla. At 11:10 Danny Moon on a pass from Ferguson and Lanteigne shot home Marathon's second goal. At 11:40, Al Lanteigne skated past the defence fooled the goalie and made the score 6 to 3. Penalties, Kapitan Marathon tripping 28 seconds, Ward, Nipigon, interference 9:05, Bolan Marathon spearing 17:50.

The third period threatened to get slightly out of hand when Marathon fought desperately to win, only to be held down by the Flyers. At 6:11 H. Manilla scored Nipigon's final goal on an assist from his brother, Danny Moon, assisted by Ferguson and Romano scored the final goal of the game leaving the score Nipigon 7, Marathon 4.

World Hockey Games Remaining

Here is the schedule of the remaining games in the World Hockey tournament. Thursday: Canada vs Sweden 7 a.m.; Czechoslovakia vs Russia 12 noon. Friday: Sweden vs Finland 7 a.m.; Czechoslovakia vs U.S. 12 noon. Saturday: Russia vs Finland 7 a.m.; Canada vs U.S. 12 noon. Sunday: Russia vs Sweden 2 a.m.; Czechoslovakia vs Canada 7 a.m.

For photographs of traffic and streets crowds try to shoot from an elevated vantage point above a busy corner.

For that scenic picture, place a few people in the foreground to add interest, balance and perspective.

HOCKEY AT THE THISTLE PLAYOFF HOCKEY TONIGHT - March 12th - 8.30 p.m. FORT FRANCES CANADIANS vs KENORA THISTLES 5th Game Thunder Bay Series BANK NIGHT \$30.00 ADMISSION: ADULTS \$1.00

SPRING CLEAN-UP

OF THE LARGEST SELECTION OF

SAFE-BUY USED CARS

IN KENORA

Penner Motors invite you to look over their tremendous variety of used cars. All have been thoroughly checked and are ready to give you many, many miles of trouble-free summer driving. And you can save money too during our spring clean up. Compare for yourself - try Penner's before you buy.

1958 CHEVROLET Bel-Air 4 door sedan. 2 tone blue and white, V-8, radio, automatic transmission, white wall tires, low mileage, one owner. PENNER PRICE \$2865	1957 FORD Fairlane 500. 4 door hardtop, V-8, 2 tone yellow and black, radio, automatic transmission, seat covers, fender mirrors. PENNER PRICE \$2435	1957 METEOR Rideau 500 2 door hardtop. 3 tone black - yellow - white, radio, auto. transmission, power steering, white wall tires, seat covers, fender mirrors. PENNER PRICE \$2585	1957 MERCURY Montclair 4 door sedan. Pushbutton automatic trans., 2 tone pearl and rose, fender mirrors. PENNER PRICE \$2965
1957 FORD Fairlane 500 2 door. 2 tone blue and white, V-8 motor, seat covers. PENNER PRICE \$2365	1955 FORD 4 door. 2 tone green and white, radio, seat covers. PENNER PRICE \$1435	1957 FORD 2 door. Black, very clean 1 owner car. PENNER PRICE \$1885	1956 METEOR Rideau 4 door. Black and white, V-8 motor, seat covers, new paint. PENNER PRICE \$1685
1954 HUDSON Hornet. Power packed motor, radio, very clean. PENNER PRICE \$1150	1953 BUICK 4 door. 2 tone green, dynaflo transmission, radio. PENNER PRICE \$1325	1953 METEOR Custom 4 door. 2 tone white and maroon, seat covers, very clean. PENNER PRICE \$950	1953 PLYMOUTH Belvedere 4 door. 2 tone green, custom radio, low mileage. PENNER PRICE \$935
1955 STUDEBAKER 4 door Champion. Custom radio, overdrive. Very clean one owner car. PENNER PRICE \$825	1952 METEOR 4 door. 2 tone blue and white, seat covers. Exceptionally clean. PENNER PRICE \$765	1952 CHEVROLET 2 door. Red and black, seat covers, new paint. PENNER PRICE \$695	1953 MONARCH 4 door. 2 tone blue and white, auto. transmission, radio, seat covers. PENNER PRICE \$965
1952 STUDEBAKER 4 door. Grey. PENNER PRICE \$585	1952 MONARCH 4 door. 2 tone green and white, seat covers, new paint. PENNER PRICE \$785	1951 PONTIAC 4 door. Brown, new seat covers. PENNER PRICE \$595	1953 CHEVROLET Sedan Delivery. Maroon. PENNER PRICE \$845
1955 FORD 4 door. Radio, 2 tone brown and white. PENNER PRICE \$1450	1956 CONSUL 4 door. Blue, low mileage, 1 owner PENNER PRICE \$1350	1951 FORD 2 door. Radio, very clean interior and exterior. PENNER PRICE \$650	1953 METEOR 2 door. White and maroon, seat covers. PENNER PRICE \$935

SAFE-BUY TRUCK BARGAINS

1956 G.M.C. Model 9700 PENNER PRICE \$2650	1955 FARGO 1/2 TON PENNER PRICE \$965	1953 MERCURY 1/2 TON PENNER PRICE \$835	1952 MERCURY 1/2 TON PENNER PRICE \$695	1952 MERCURY 1/2 TON PENNER PRICE \$365
--	---	---	---	---

1959 METEOR GIVEN AWAY FREE!!

YOU CAN WIN

TICKETS WILL BE GIVEN ABSOLUTELY FREE ON ALL PURCHASES \$2.00 OR OVER

WHEN YOU BUY GASOLINE, OIL, PARTS, NEW TIRES, LUBRICATION, NEW OR USED CARS YOU WILL RECEIVE FREE TICKETS. EVERY PURCHASE GIVES YOU ANOTHER CHANCE. IN ADDITION - THERE IS A FREE DRAW ON LOVELY CUTLERY FOR THE LADIES EVERY MONTH - AND A FREE DRAW ON A BOY'S OR GIRL'S BICYCLE EACH MONTH. TO QUALIFY YOU NEED ONLY PURCHASE YOUR DAY-TO-DAY DRIVING ESSENTIALS. TICKETS ARE FREE.

Tickets Given at Penner Motors in Kenora Only



PENNER MOTORS

(KENORA) LIMITED

SHOWROOM OPEN EVENINGS TILL 9 P.M.

HIGHWAY 17 EAST

PHONE 9831

KENORA, ONT.

WHERE CARS ARE ALWAYS SOLD FOR LESS



Fort Frances Work Project Gets Airing

Instead of getting a bargain, the Fort-Frances town council commented Monday night the winter work assistance being received from the federal and provincial governments is a gainless proposition.

THE MUNICIPALITY took advantage of the 75 per cent subsidy offered by the senior governments to move a waterline out of

the road of the planned Portage avenue subway.

But Councillor Len Connor, chairman of public works, informed the council that the deal has turned into a case of the town subsidizing the federal government.

Whereas councillors expected to get some of the unemployed married men of the community off the municipal relief roll, the men being sent to the job by the National Employment Service include some bachelors without dependents. Only men sent by the NES are eligible under the winter works program, Connor explained.

THE WORKS chairman said he

didn't know what the council could do about the situation "unless we ditch the whole deal and put our men on it."

The council earlier had lined up several projects to reduce its welfare load and put relief claimants to work but it is likely these will now be laid over. Councillors commented the NES is more interested in putting to work men who are drawing unemployment insurance benefits than giving jobs to other men no longer on the federal payroll.

In other business transactions, the council:

- Approved purchase of replacement and new machinery totalling \$41,035. Although the list of equipment covered included a new grader for \$25,000, the grader may not be purchased immediately.

OBJECT OF THE BY-LAW was to have the total purchase approved by the Ontario municipal board. Equipment definitely scheduled for purchase include a one-ton truck, for about \$3,000; a compressor, \$4,970; and an asphalt mixer, \$8,065.

- Discussed need for a new power substation recommended by Bela Toth, electrical engineer. Toth also suggested a meeting with electrical officials of the O-M company to find out how far Fort

Frances electrical expansion can proceed without taxing O-M power resources. The town purchases power from the paper company.

- Learned from councillors who met unions of town employees last week that negotiations are still continuing.

- Discussed with J. C. Smith, attorney, the plans of Husky Oil company to open a combined restaurant and service station of King's Highway. Smith emphasized that council should move fast to approve Husky plans or lose an industry that will probably support 12 families

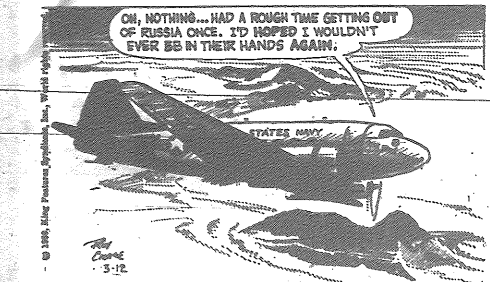
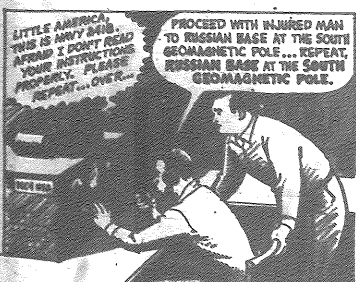
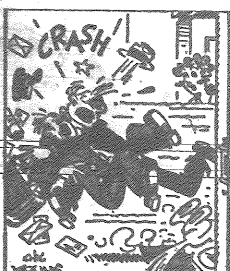



TWENTY-FIFTH ANNUAL POLICE BALL

TO BE HELD IN THE LEGION AUDITORIUM
FRIDAY, MARCH 20th, 1959

COMMENCING AT 9.00 P.M.

ADMISSION: \$1.00 PER PERSON

NO PERSON UNDER 21 WILL BE ADMITTED



Beauty is Real
Time is an Illusion
with *Elizabeth Arden's Essentials*

The ticking clock is only a meaningless sound to women who are faithful to Elizabeth Arden's Essentials. From the day you're fifteen, all you need do is Cleanse, Refresh, Smooth... but do it every day—the Elizabeth Arden way. Cleanse with Ardena Cleansing Cream 1.50 to 8.00, Refresh with Ardena Skin Lotion 1.50 to 5.50, Smooth with Ardena Veiva Cream 1.50 to 4.50.

Elizabeth Arden

Johnson's
PHARMACY

MAIN STREET

SECOND STREET

Custom Electronic Enterprises

— Exclusively WESTINGHOUSE Sales. World Renowned QUALITY With Locally Recognized Reputation for SERVICE Makes:—

WESTINGHOUSE TV

YOUR LOGICAL CHOICE

You Can Be SURE If Its Westinghouse

EATON'S Great Spring Sale

TWO DAYS
FRIDAY and SATURDAY
MARCH 13th - 14th
SHOP NOW FOR SPRING AND EASTER

Smart Reclining Chairs



Plastic Seats
Toilet seat of light plastic construction that won't chip or peel. Easy to keep clean and sanitary. Crane colours or white. Designed to fit all regular size bowls. **5.95**
Sale Price, each



Ordinary Value 79.50

Here's comfort and value in a chair that's almost certain to be the favourite in your home.

Large size with built-in foot-rest for complete relaxation. Covered in combination washable "Naugahyde" plastic and reinforced nylon fabric. Decorator shades include green, beige, brown, red or black. **Sale Price, each,**

59.95

BUDGET TERMS AVAILABLE

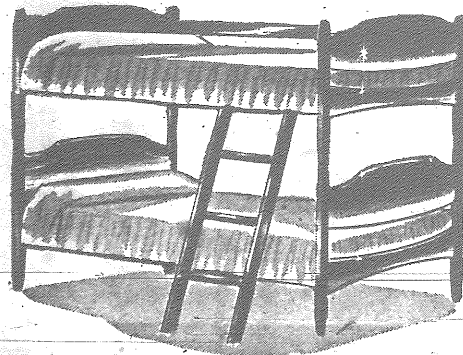

Newly Styled Bunk Beds

The Youngsters Will Love These!

Comfortable, double-decker bunk beds—offered at an exceptionally low price during EATON'S Spring Sale. Neatly styled with tapered pillars, sturdily constructed of hardwood, with good coil spring-filled mattresses and steel slat springs. In fresh looking light oak-grain finish. Beds can be separated to make two twin beds. 5-foot size. **Sale Price, complete,....**

99.50

BUDGET TERMS AVAILABLE

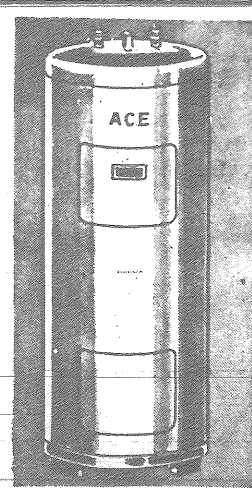

'Ace' Water Heaters

ELECTRIC Glass-Lined Water Heater

With glass fused to steel to give clear, sparkling hot water. One upper and one lower immersion type heating element for faster hot water recovery... both elements thermostatically controlled. *Fibreglas insulation for small heat loss. Temperature and pressure relief valve included. **30 Imperial Gallons—(As Illustrated). Sale Price, each, 96.50**

BUDGET TERMS AVAILABLE

GAS Glass-Lined Water Heater

With glass fused to steel to give clear, sparkling hot water. Highly efficient cold water inlet tube. *Fibreglas insulated for smaller heat loss. Baked enamel finish.

22 Imperial Gallons—(Not Illustrated). Sale Price, each, 94.50

BUDGET TERMS AVAILABLE

*Trade Mark

IT PAYS TO SHOP AT EATON'S

THE T. EATON CANADA CO. LIMITED

TO CALL EATON'S DIAL 6467.

EATON'S: New, 1959 VIKING Deluxe Refrigerator 10.5-Cubic Feet with Extra Large Freezer Chest

Trimly Styled, Built for Service and Satisfaction. This New VIKING Has Many Convenient Features and a Low Sale Price — See and Buy It at EATON'S Now!

Homemakers will be thrilled with this value . . . note the extra large freezer chest that holds 43.8 pounds of frozen foods and the spacious food compartment—designed for once-a-week shopping. Handsome styling, plus generous capacity combine to make this a great value for EATON'S Spring Sale. Check the features:

- Large, across-the-top freezer chest.
- Full-width chiller tray.
- Large, roomy 20.6 cf. crispers.
- Deluxé door shelving.
- Easily adjustable temperature control, automatic interior light!
- Gleaming white enamel finish.

VIKING Model 910V — Sale Price, each

229.00

BUDGET TERMS AVAILABLE

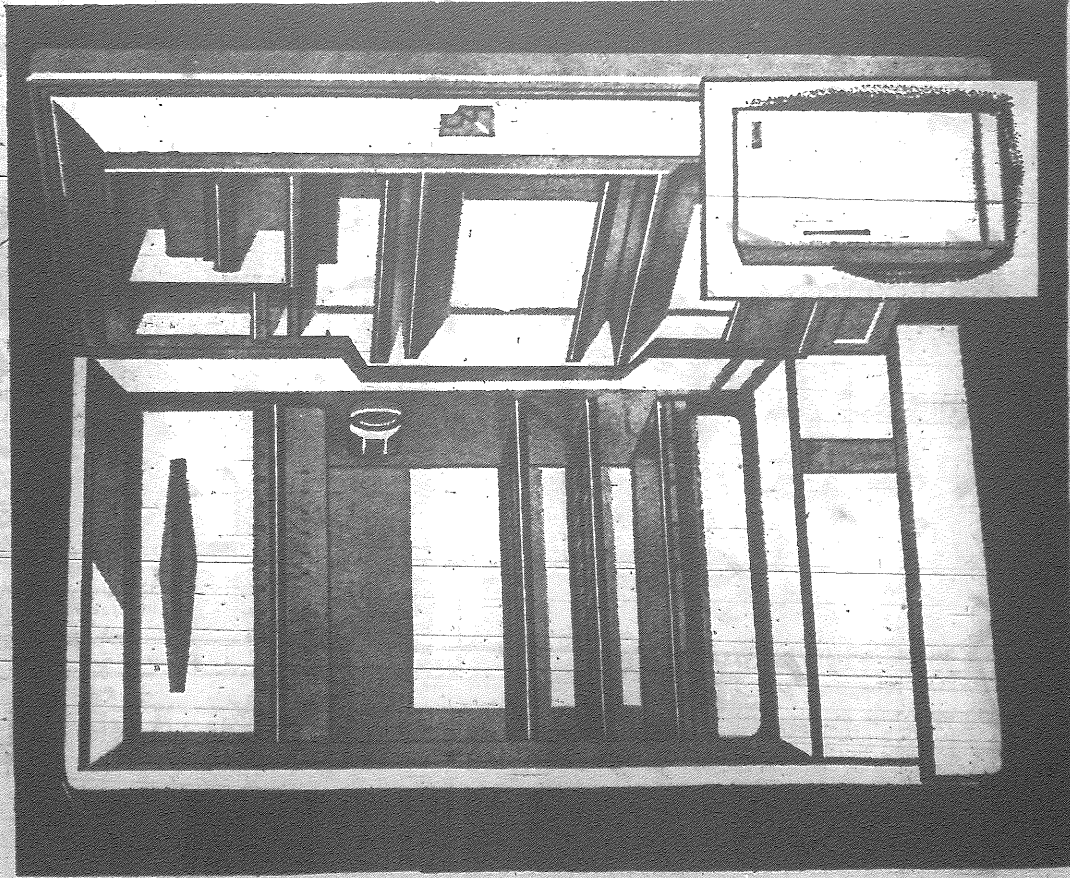

VIKING Deluxe 17 - Cu. Ft. Home Freezer

A Timely Sale Value!

A helpful appliance for today's modern home! You can bake in quantity, fix lunches ahead of time, prepare complete meals weeks ahead—before you actually need them. Then, come Summer, you can freeze fresh fruits and garden vegetables — store meats for months. This VIKING freezer offers fine design, quality workmanship and deluxe features.

- 17 cu. ft. capacity stores approximately 375 pounds.
- Special quiet freeze and regular storage compartments.
- Automatic interior food light.
- Three special wire baskets and dividers.
- Many, many more outstanding features.

VIKING Model H5917. Sale Price, each

287.00

BUDGET TERMS AVAILABLE

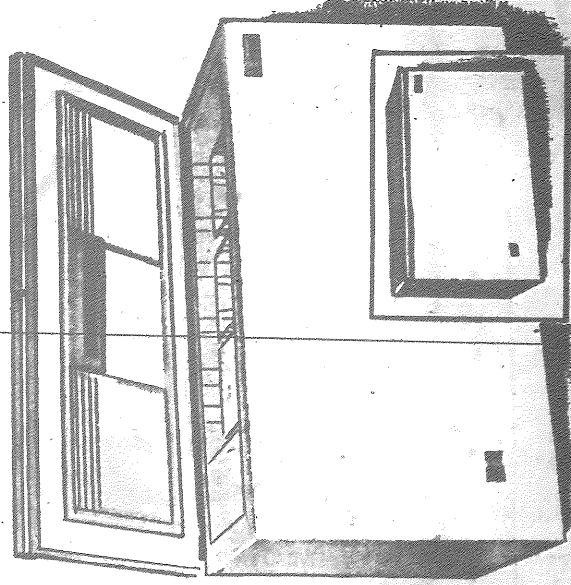

VIKING 25" Automatic Electric Range - Special Low Sale Price

A High Quality, Beautifully Styled Range With Many Helpful Features!

A modern, up-to-date VIKING range will add such convenience to your kitchen! Think of the delicious meals you'll be able to prepare... the baking you'll do and the praises you'll receive from your family and friends!

This dependable VIKING has many features that mean cooking ease and enjoyment—and it's a handsomely styled range, too. It's the right choice for your home and right about one for the quality features. This is one VIKING value you won't want to miss. In white enamel finish.

Model No. 1525H2W

Sale Price, each,

199.95

BUDGET TERMS AVAILABLE!

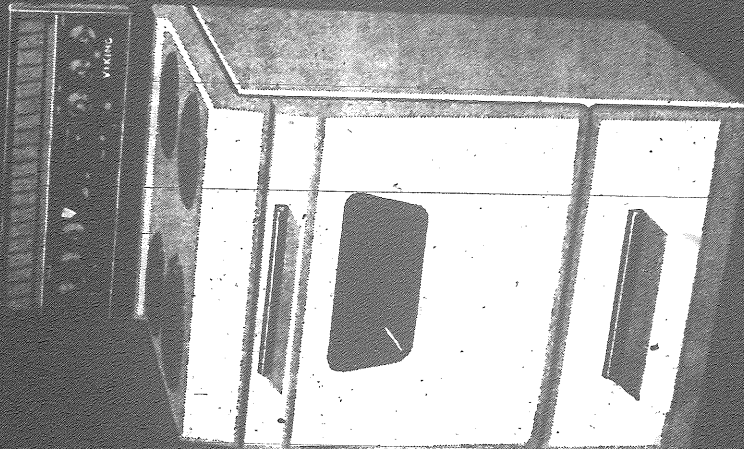

Adjustable Range Knob—Keeps cooking range steady for long, uniform cooking.



Speed-Speed Rotary—Provides five speed controls for perfect cooking.

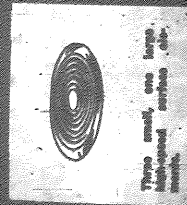

Three main air ways—Maximum carbon life.

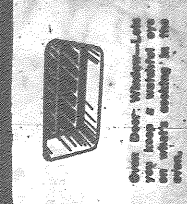

Green Door, Window-Lite—For easy viewing of contents cooking in the oven.

VIKING Electric Washer with Time and Labour Saving Pump

Modern Design, Full-Skirt Length With Automatic Roll-Stop Wringer!

An exciting Sale offer! Here's the wringer washer that gives you all the features usually found in only higher-priced machines. The VIKING is durable... built to stand up to heavy washday loads and designed to turn out a bright, sparkling wash every time. See the VIKING in action... note the low Sale price—you'll want to choose yours now and save. Check these time and labour-saving features:

- Power pump for quick, easy emptying
- Chromium-plated clothes guides
- Modern design, full skirt length
- Steaming white enamel finish
- Automatic roll-stop wringer
- Precision built mechanism, sealed in oil
- Quiet operation, 1/4 h.p. motor
- New design splitter gives a clean, gentle wash

Model No. 523P

Sale Price, each,

114.50

BUDGET TERMS AVAILABLE!

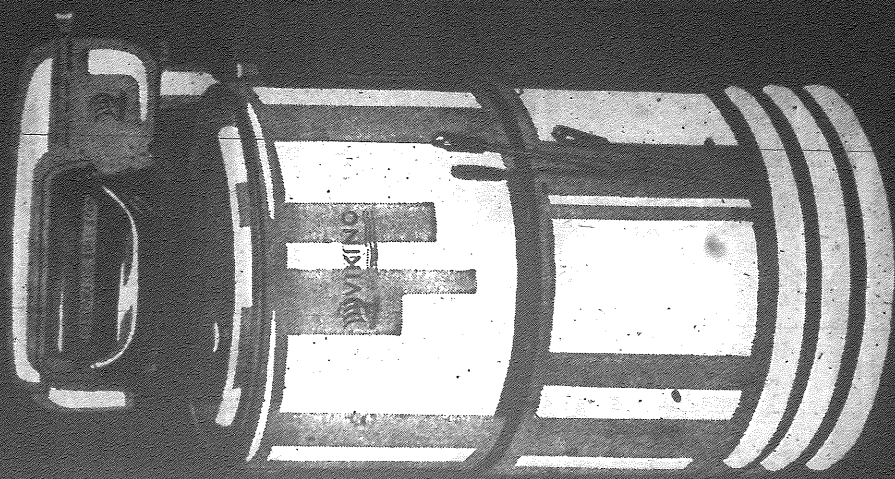

It Pays to Shop at EATON'S

Largest Assortments
Best All Round Values
Goods, Suits, Factory or Money Return

T. EATON CO.

EATON'S VIKING High-Fidelity Radio Phonograph

Regular 349.00 - Offered at a Big 50.00 Saving

"Valiant" Tank Vacuum Cleaner Complete with Attachments

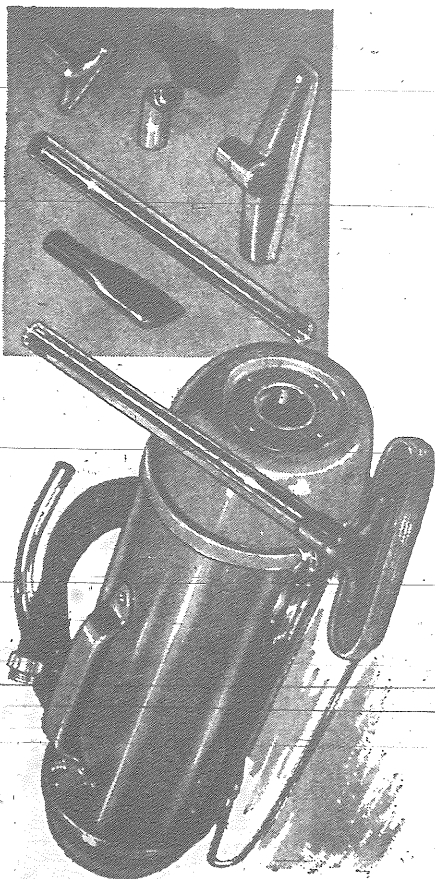

Fine Value and Backed by EATON'S Renowned Guarantee

- Imagine a price so low for a fine quality, brand new vacuum cleaner to help you with your Spring cleaning chores... it's a special low-price offer for this sale event. The "Valiant" tank vacuum cleaner is a genuine Hoover, with the features and furniture—has all the attachments for cleaning hard-to-reach areas.
- 5.5 amp. motor—no oiling necessary.
- Modern styling with powerful suction.
- All-metal construction.
- Complete.

41.95

BUDGET TERMS AVAILABLE

"Fleetway" Carpet Sweepers

A handy sale-priced sweeper for fast, in-between cleaning of rugs and runners! The Fleetway sweeper is sturdily built to give years of service—rubber-tired and bumper protects furniture, positive lock-up handle for ease-of-use. Plan to own one now to ease your weekly housecleaning chores!

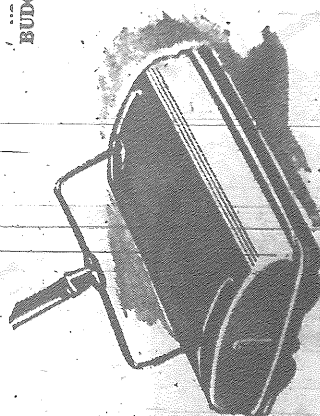

6.75

Sale Price, each

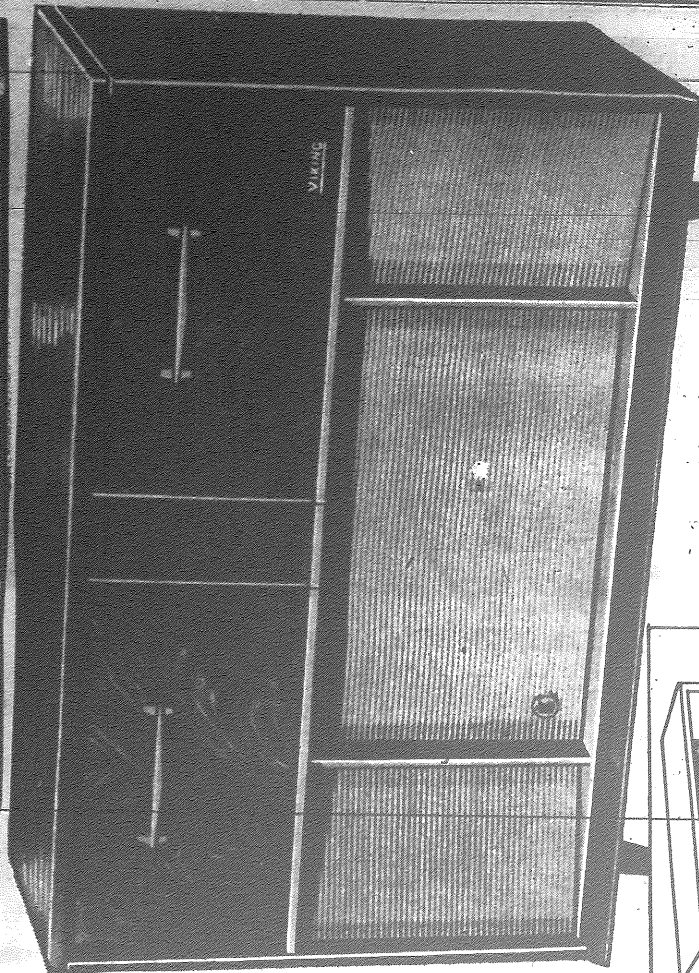

Model No. RC-361

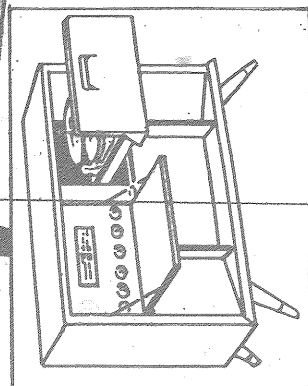

Equipped With Three Speakers, "Garrard" Automatic Changer

A leader in its price range... this quality VIKING is priced at even greater savings for EATON'S Spring Sale! See it and hear it first thing... you'll be thrilled with its superb tonal qualities and sleek styling. This VIKING HE-FI instrument is made to EATON'S strict specifications to assure you of fine performance and satisfaction. Check these features:

- 9-tube powerful radio chassis.
- 4-speed "Garrard" changer with magnetic cartridge.
- Three speakers—two 12-inch woofer and two 5-inch tweeters.
- 50 db level and 10-mour control.
- Ultrasonic tone arm for best records.
- Least lack for tone records.
- Changer wired for stereo cartridge.
- Tree-wood veneer cabinets.
- Walnut or mahogany finish.

BUDGET TERMS AVAILABLE

299.00

Walnut or mahogany finish. Sale Price, each. Budget Terms Available. Autumn Leaf Mahogany, Lined Oak or Swedish Walnut. Sale Price, each, 309.00

the look
of Easter,
fresh... feminine...
flattering

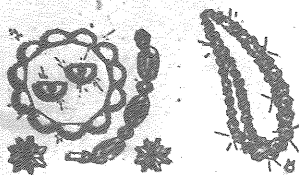

gay fashion accessories
in many-based fashion-of-year!
and glittering gem. Right.
Right touches that complement
your loveliest Spring costumes...
cost surprisingly little!

\$1.00 Up



In the Easter Picture

Handsome Handbags

with the emphasis on
simple but elegant shapes
and a slender look...
choose from our good
selection.

\$2.95 TO \$13.50

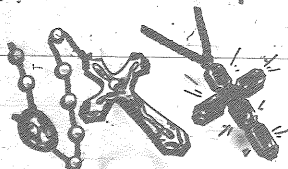

Religious Jewellery

A WIDE SELECTION OF
CROSSES, ROSARIES, ETC.
AT PRICES TO SUIT EACH
AND EVERY BUDGET

for Easter's **Beautiful Bride**



**8-Diamond
Bridal Duo**

Rings she'll wear with pride
and pleasure "forever af-
ter." Both for **\$425**
Diamond **\$350**
Wedding Ring **\$75**

We have a glorious selection of
dazzling treasures for the Easter bride... everything
from magnificent diamond rings to
gifts of enduring beauty for her new home!

**FREE INSURANCE
FOR ONE YEAR**

**COMPLETE PRIVACY IN OUR
DIAMOND ROOM**

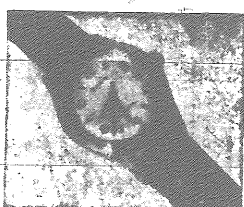

Clipper - 17J **\$49.50**

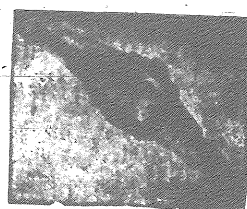

CANADIAN GIRL - 17J
Solid Bracelet
\$49.50



DIAMOND
\$250
Wedding Ring
\$50



Solitars **\$100**
To **\$750**



Famous name
watches, from **\$21.95**

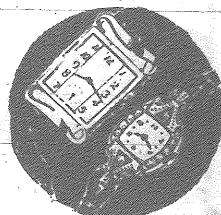

Distinctively de-
signed watches,
starting at only **\$65.00**

**TERMS
AVAILABLE**

Breslauer & Warren

130 MAIN ST.

JEWELLERS

PHONE 7912

**TERMS
AVAILABLE**

